

LCMS – Laser Crack Measurement System

John Laurent - Pavemetrics
Daniel Lefebvre - INO
Yves Savard - MTQ

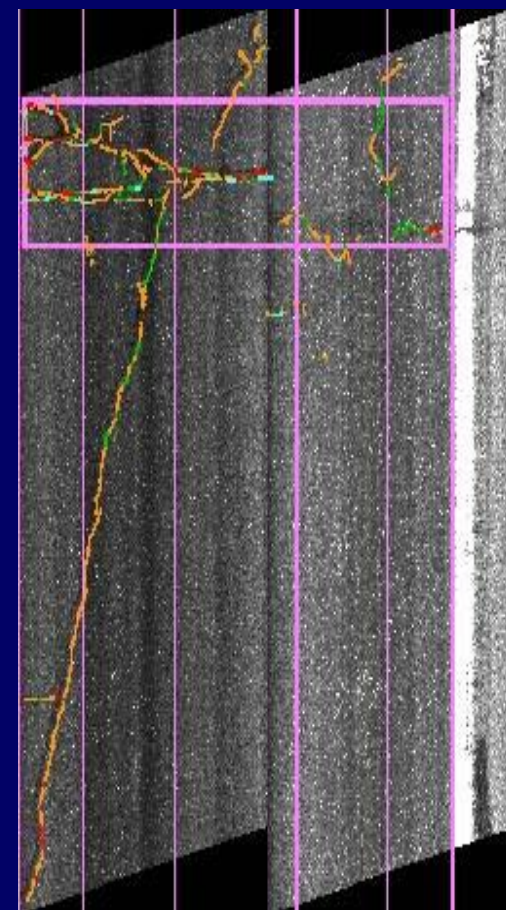

System configuration

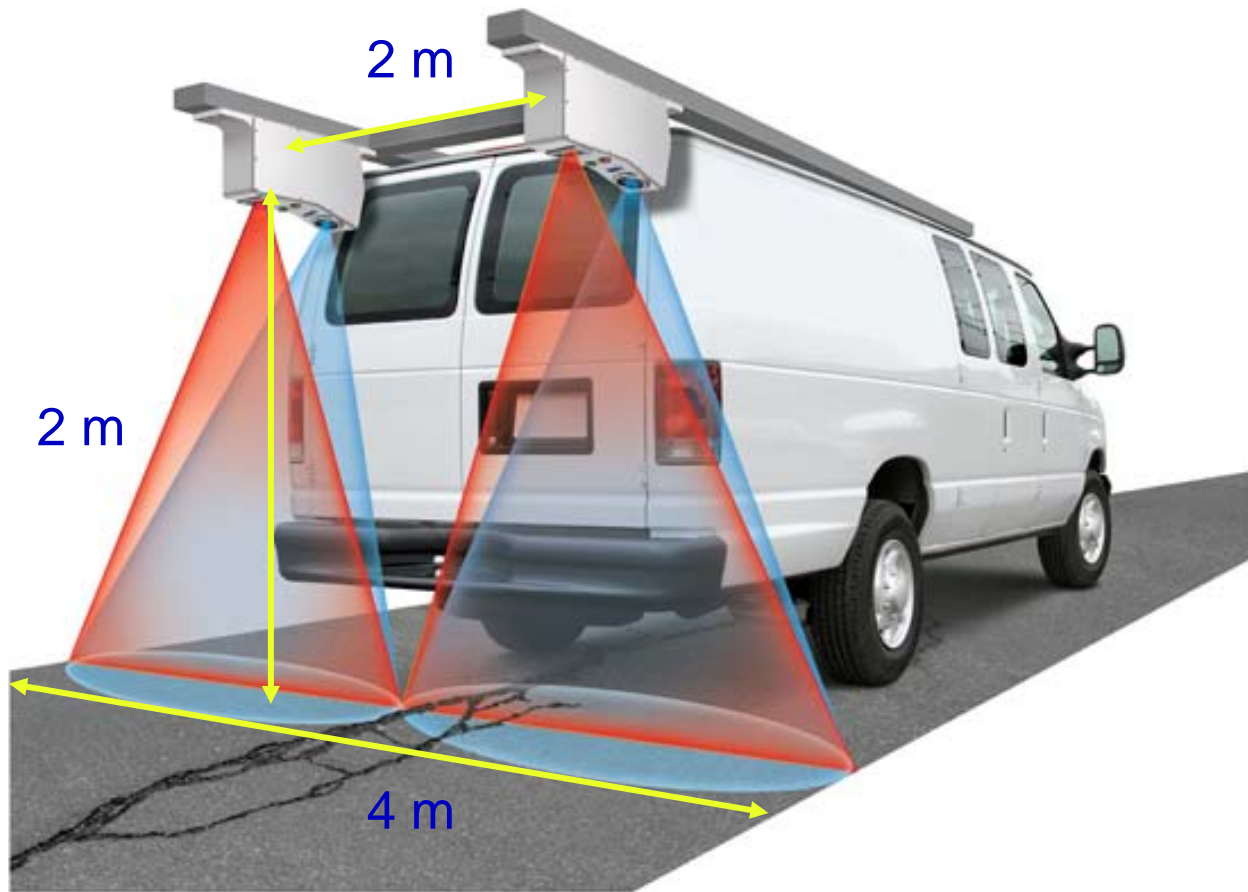

Laser profiling (principle)

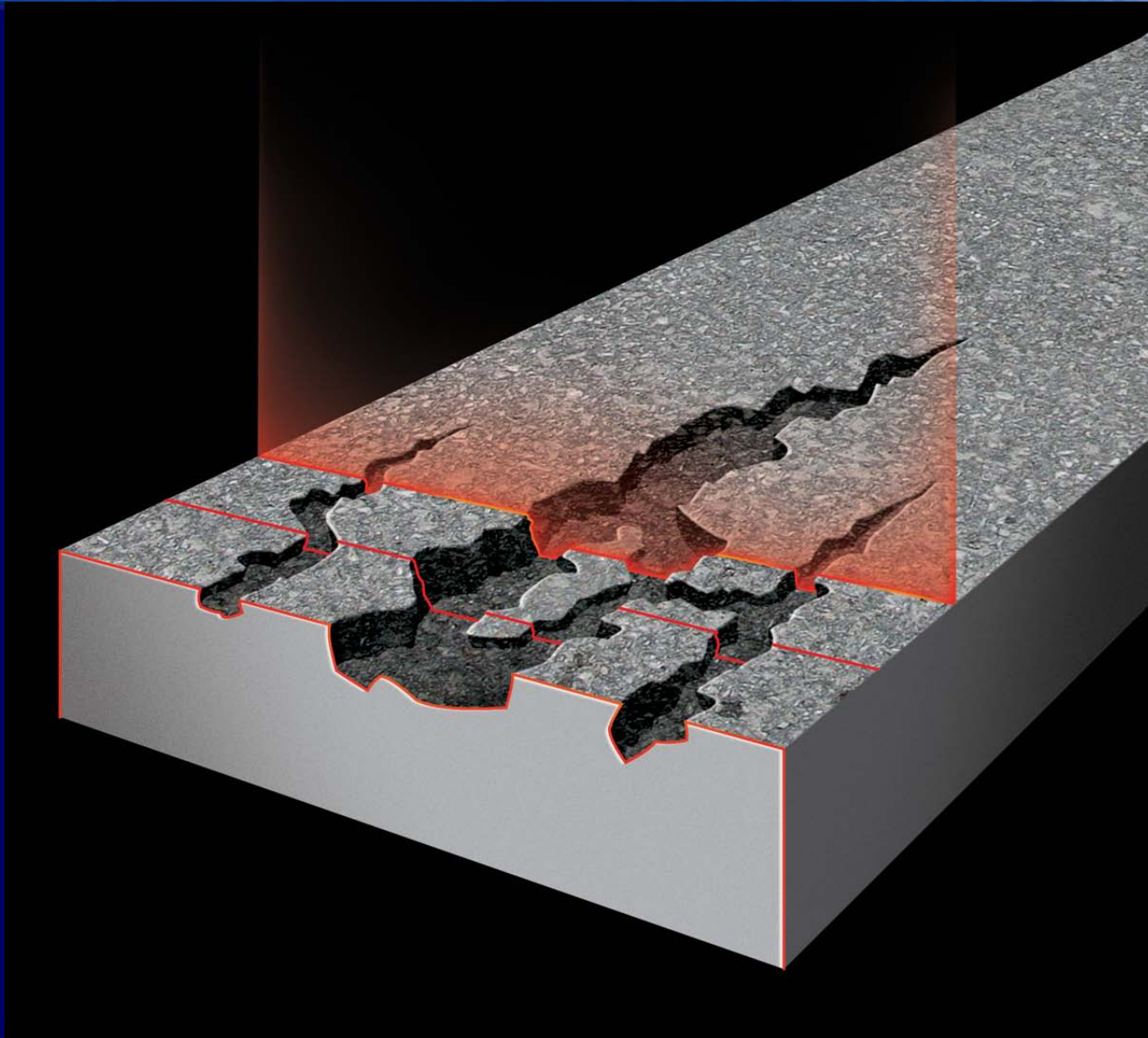

LCMS – Sensor specifications



- Profiles per second: 5600
- Points per profile: 4096
- Field of view: 4 m
- Vertical resolution: 0.5mm
- Lateral resolution: 1 mm
- Data rate: 10.4 Gb/km
(compressed) 720 Mb/km

Crack sampling intervals at 100 km/h

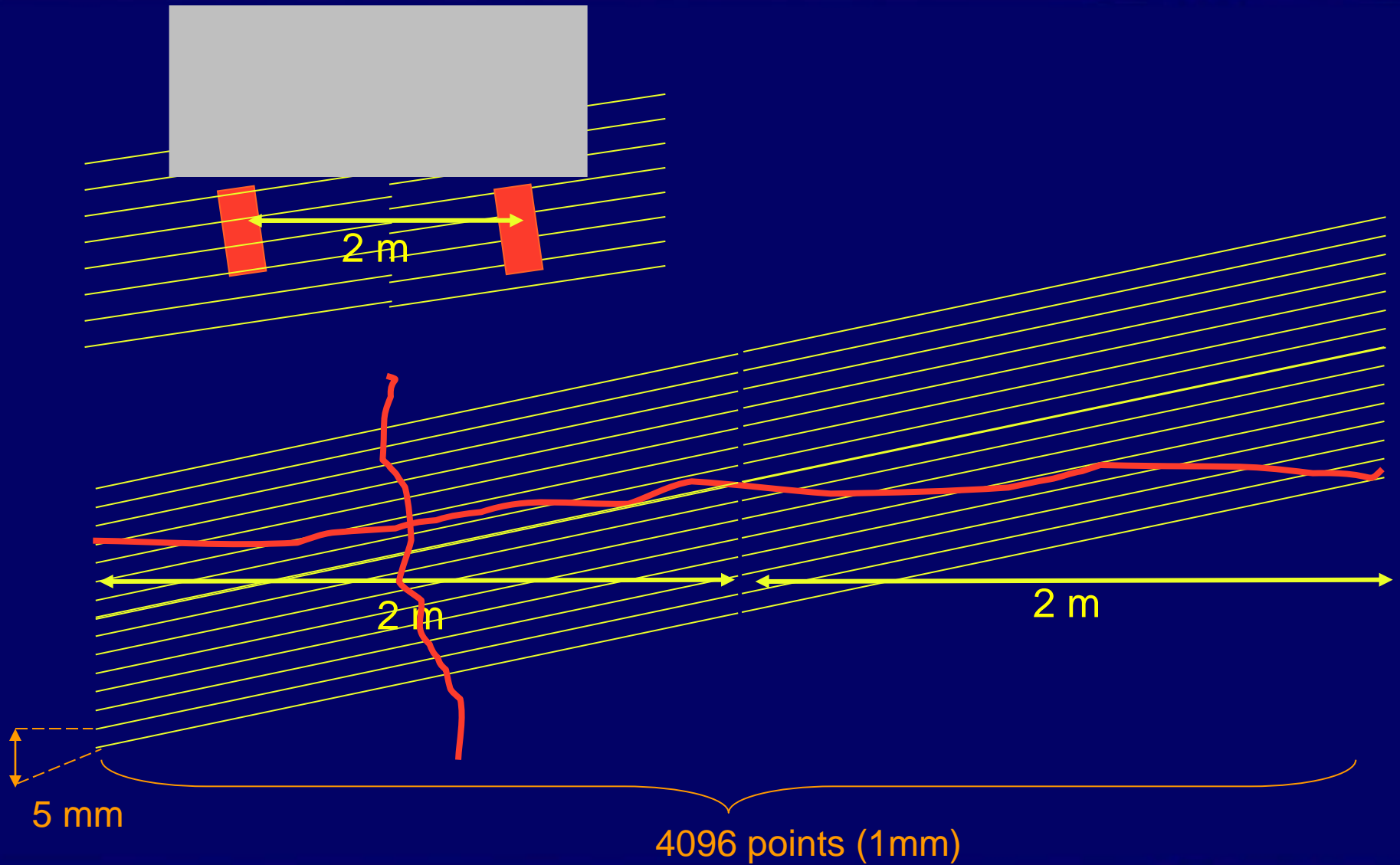

Data processing tree

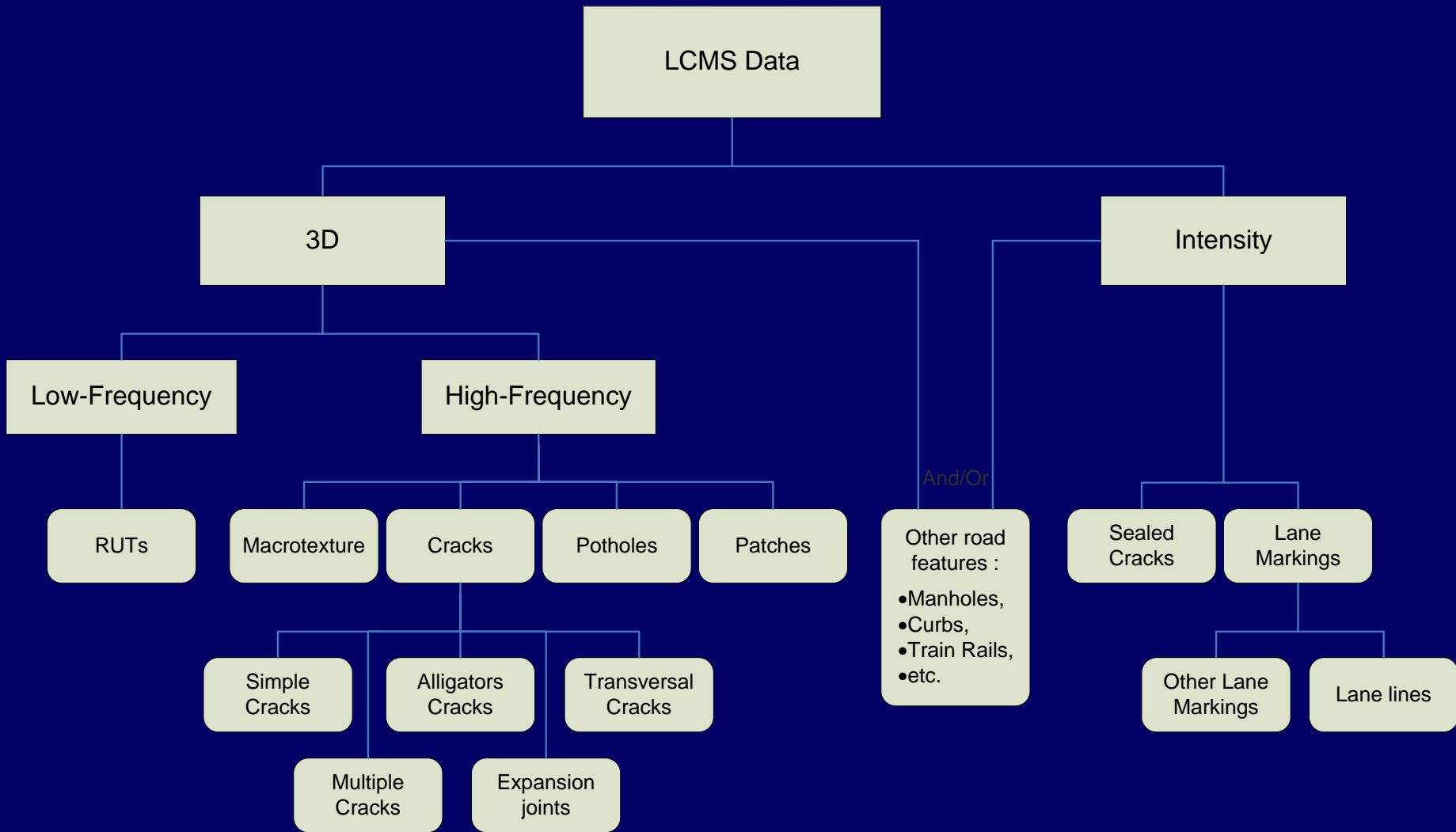

Intensity information – Lane markings, sealed cracks

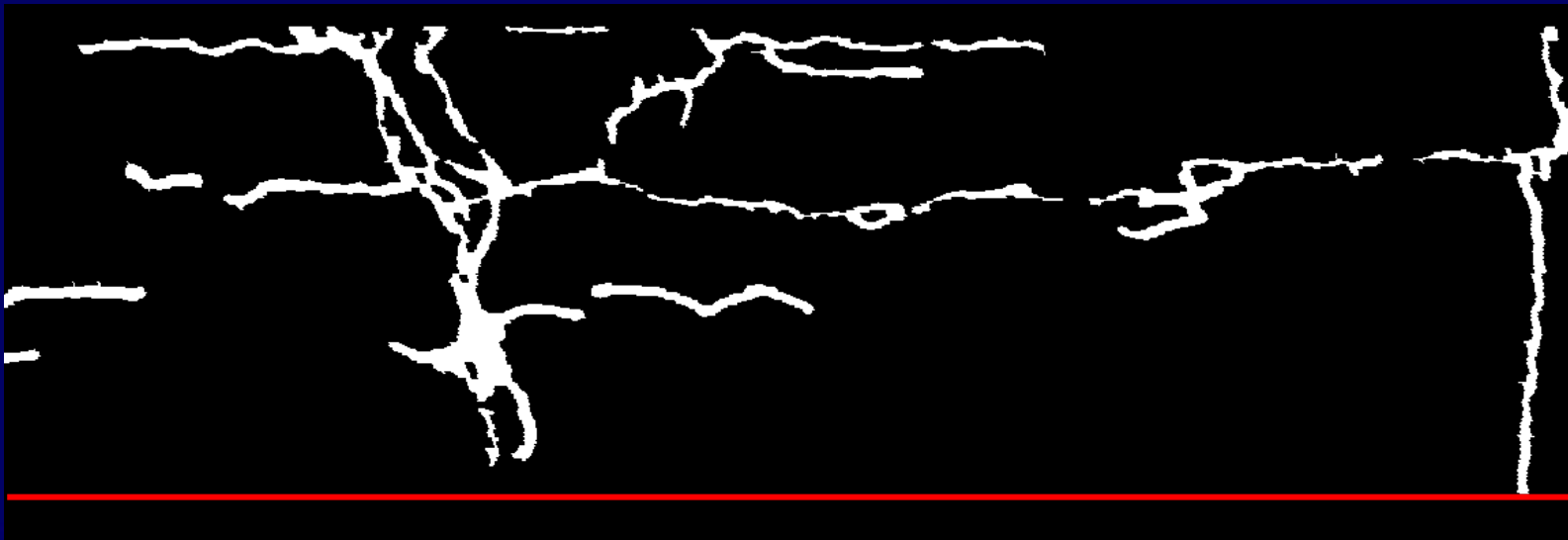
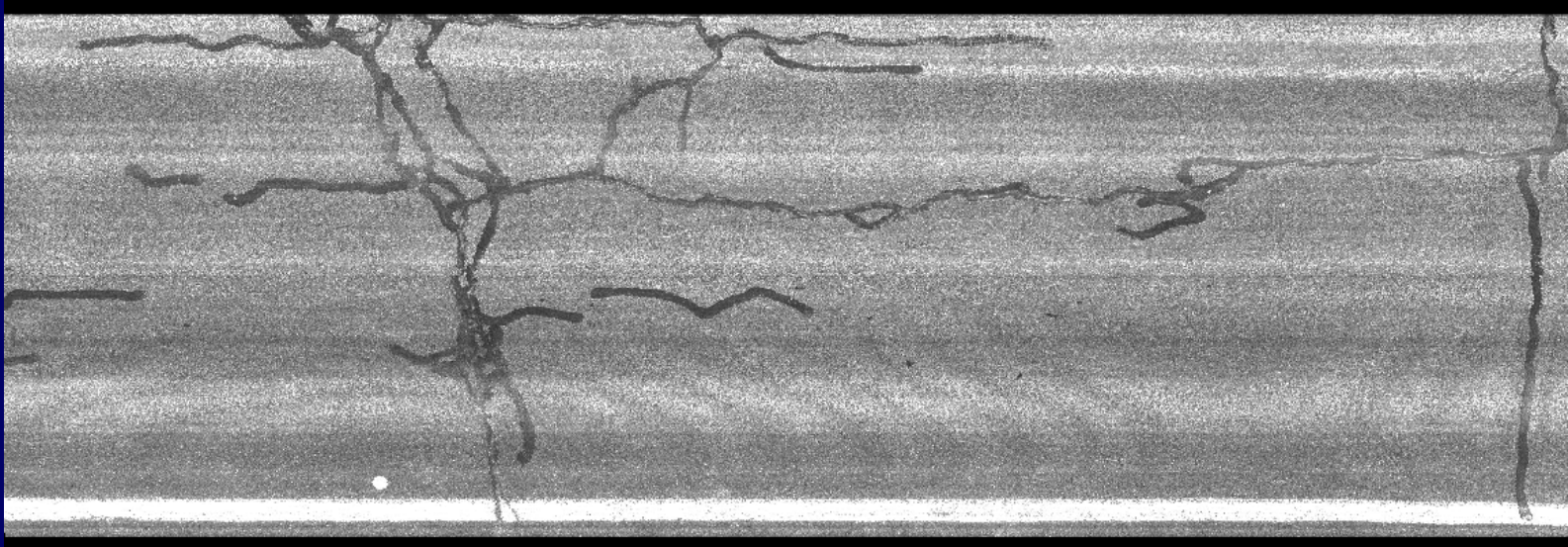

3D Crack data

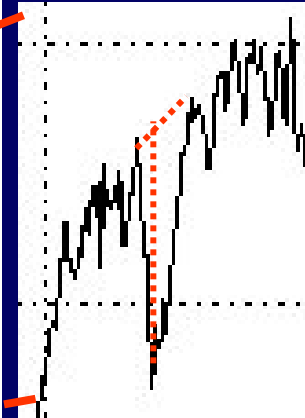
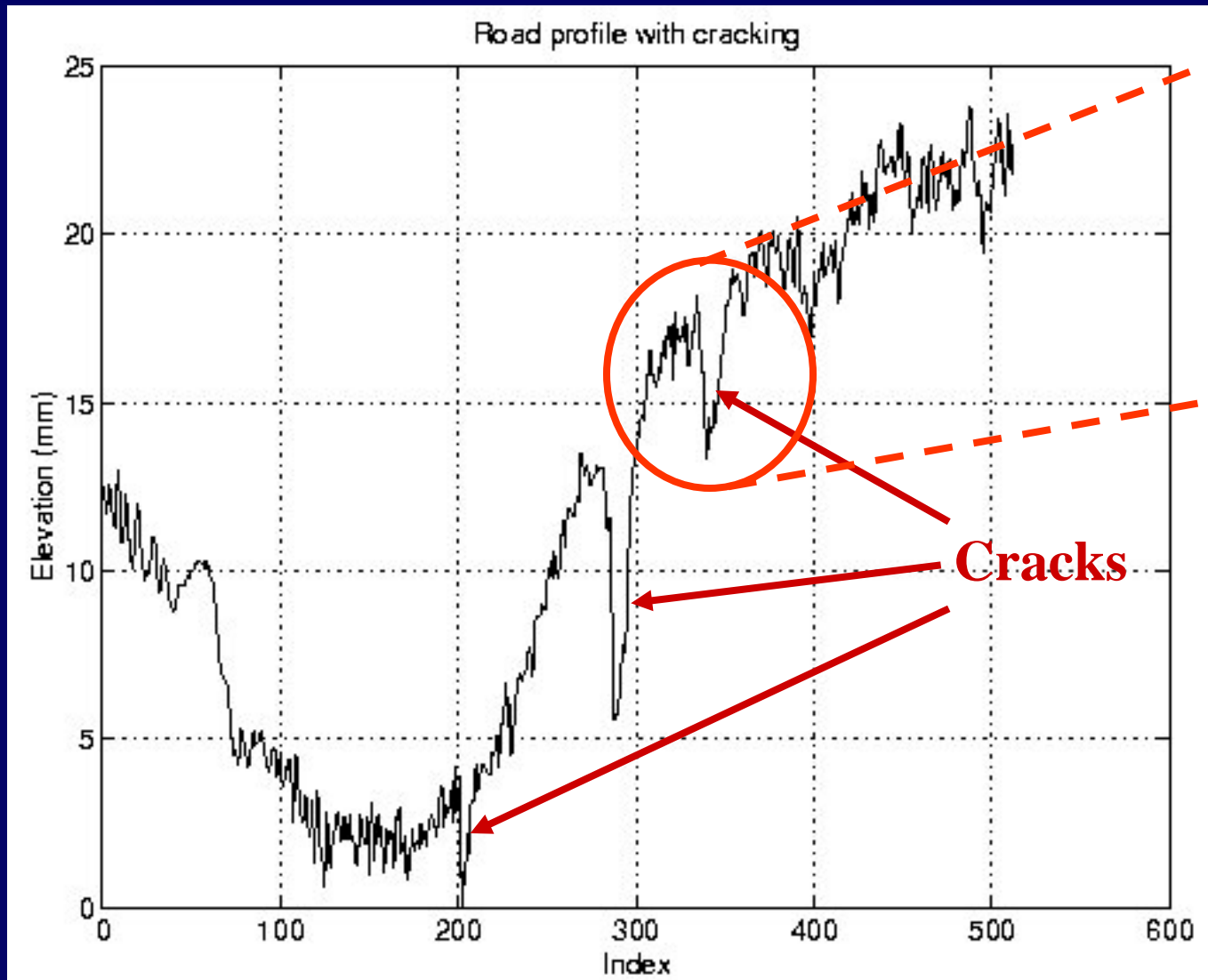

Macro-texture evaluation

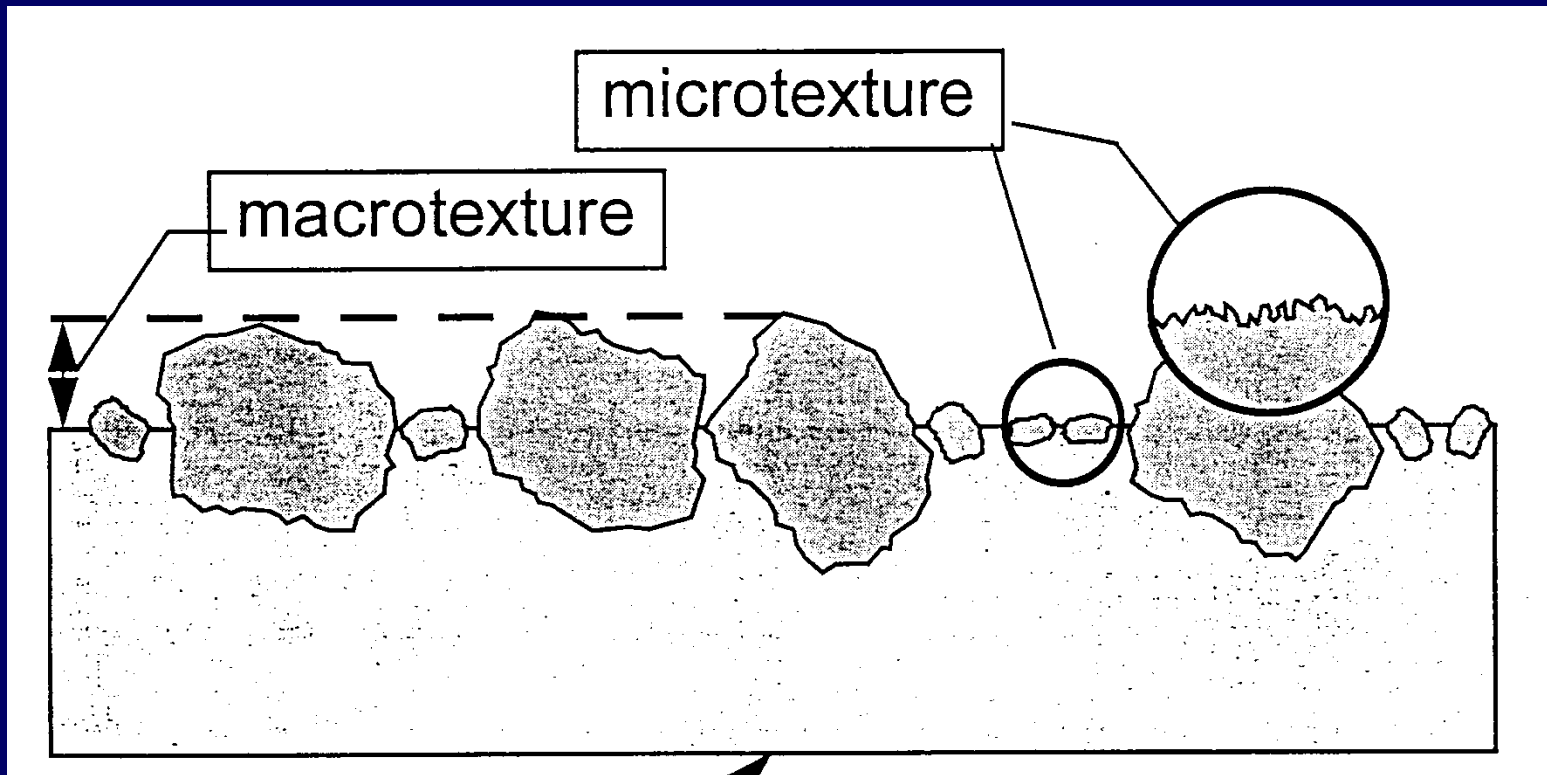

Macro-texture MPD - ASTM E1845-01

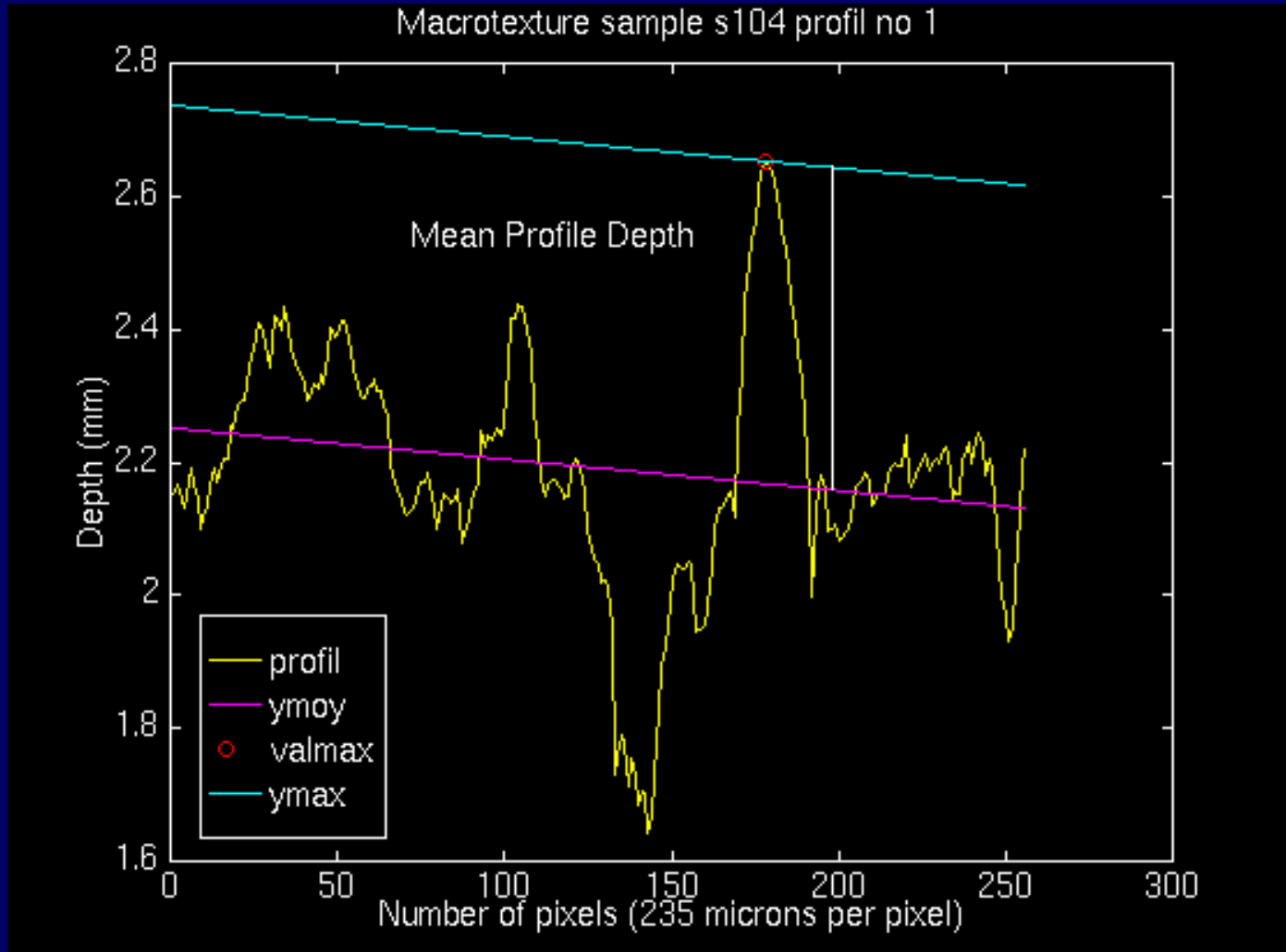

Macro-texture results (LCMS vs WDM – TM2)

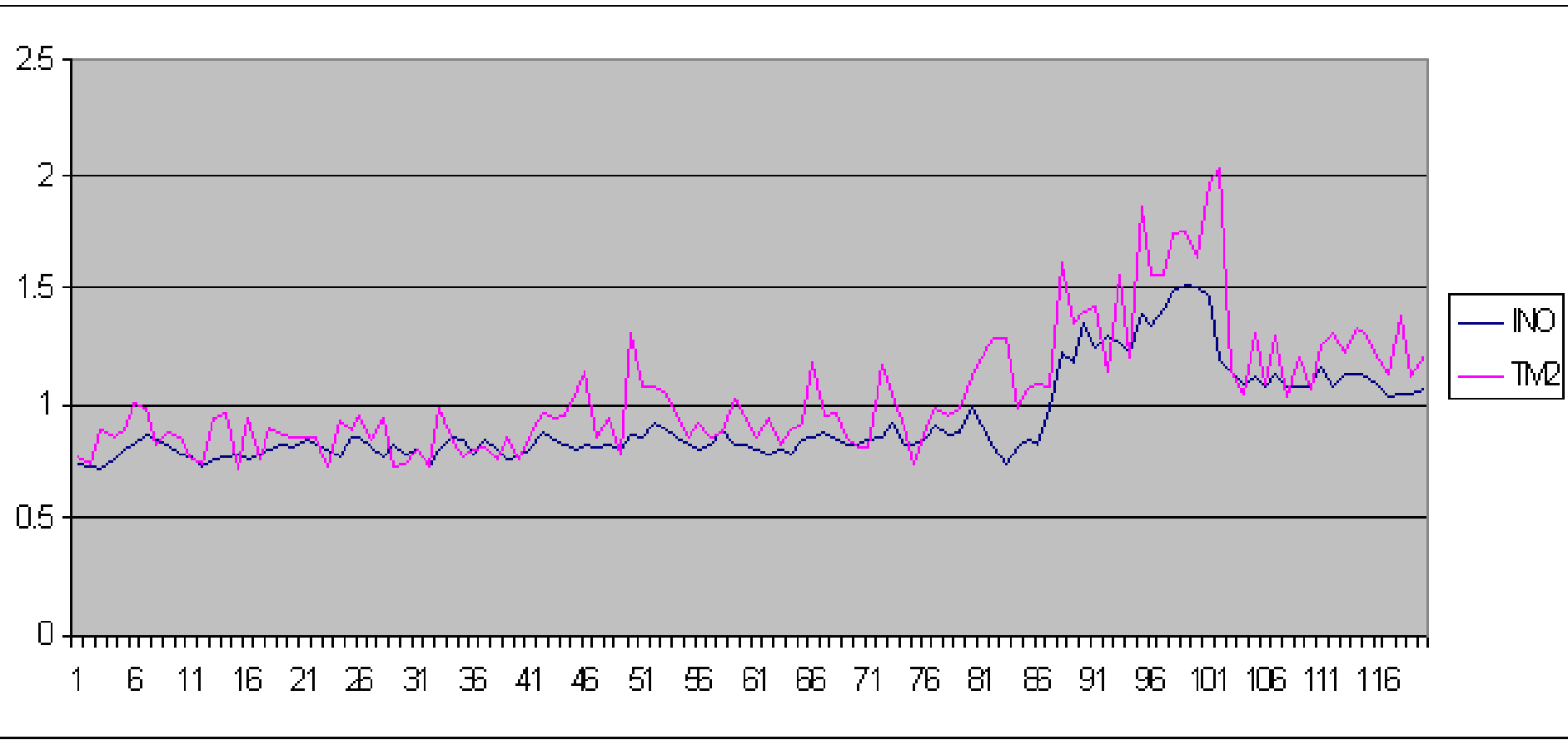

Macro-texture results (LCMS vs Dynatest)

MPD calculation results LCMS vs Dynatest (offset of 2000um)

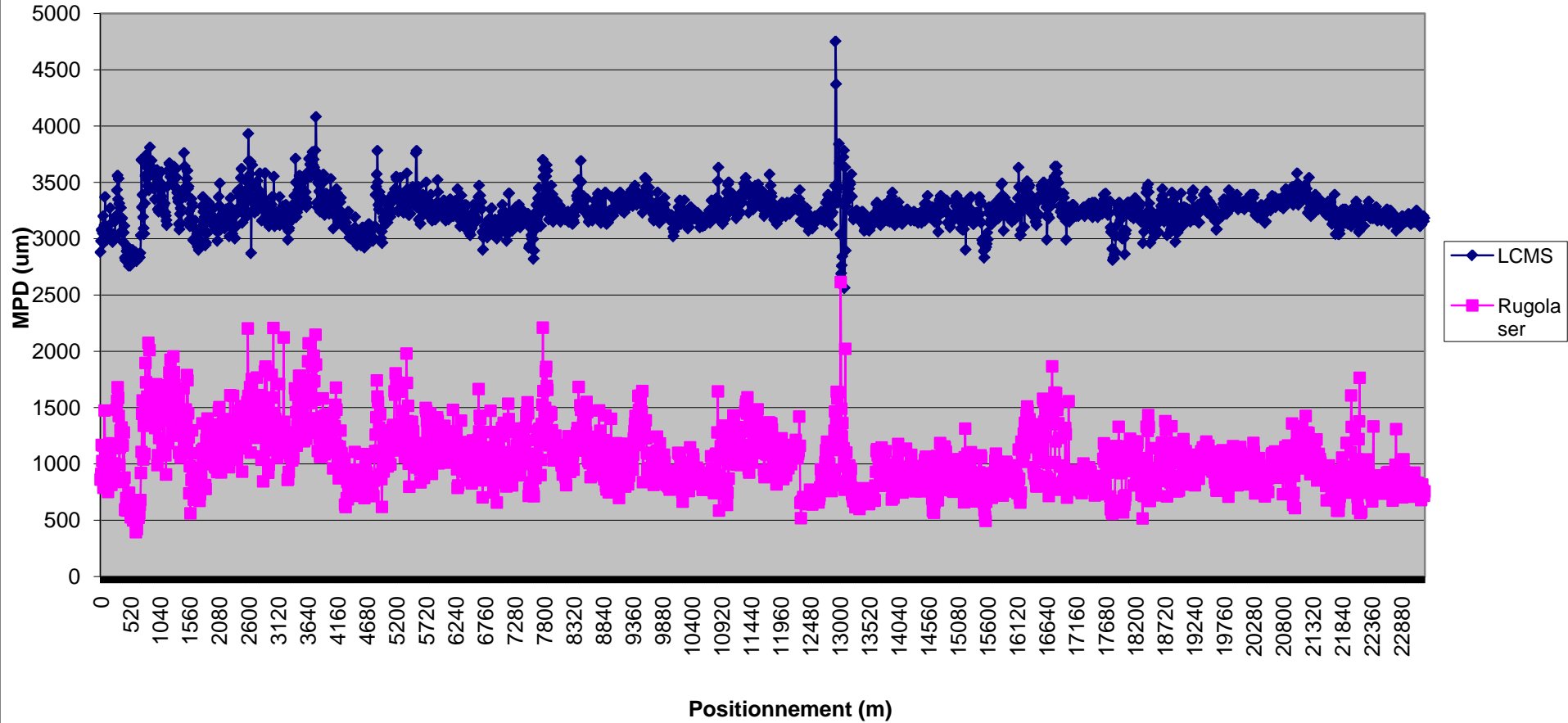

Crack detection (example)

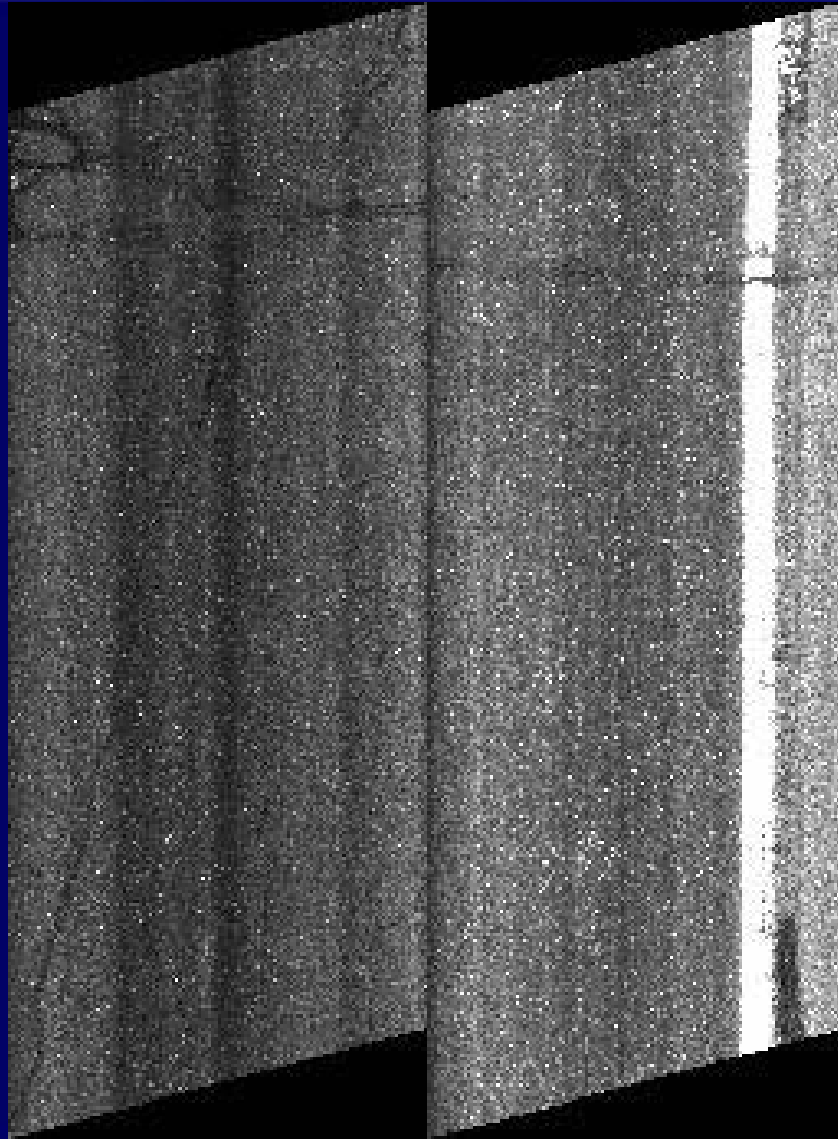

Crack detection (example)

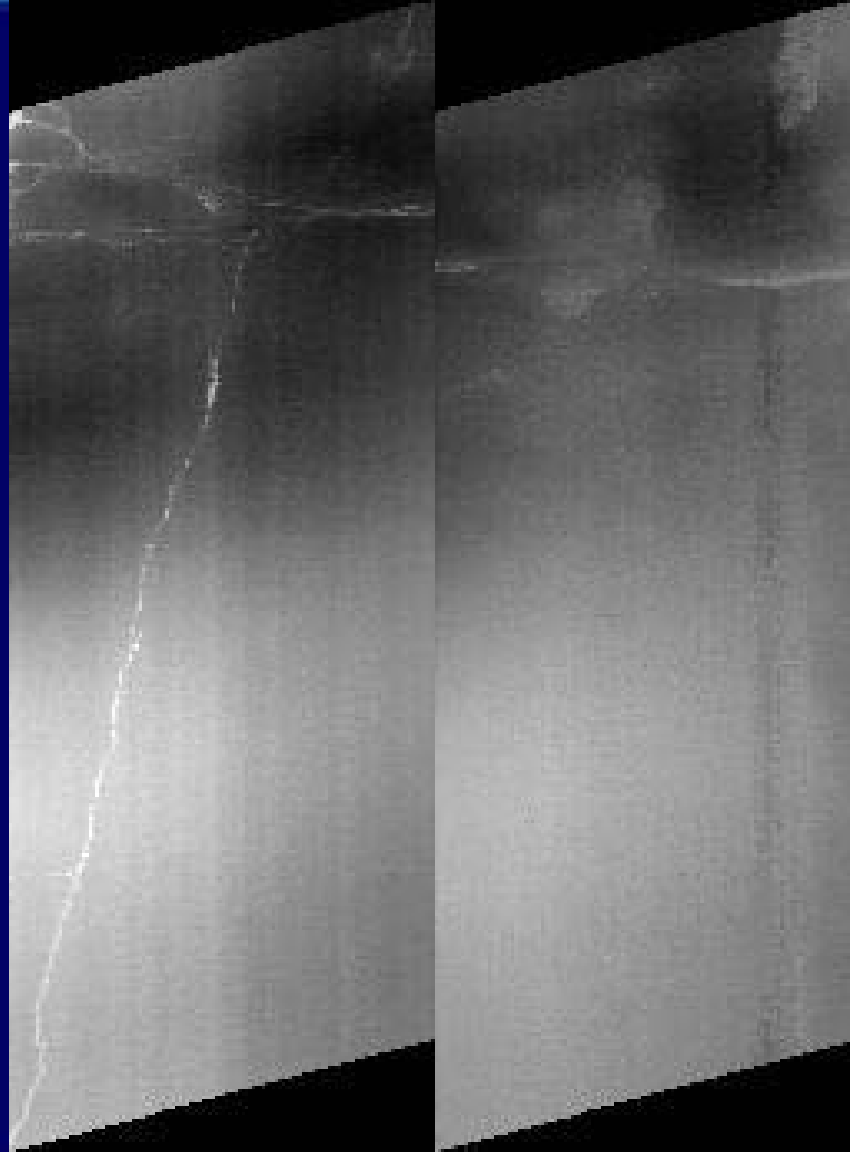

Crack detection (example)

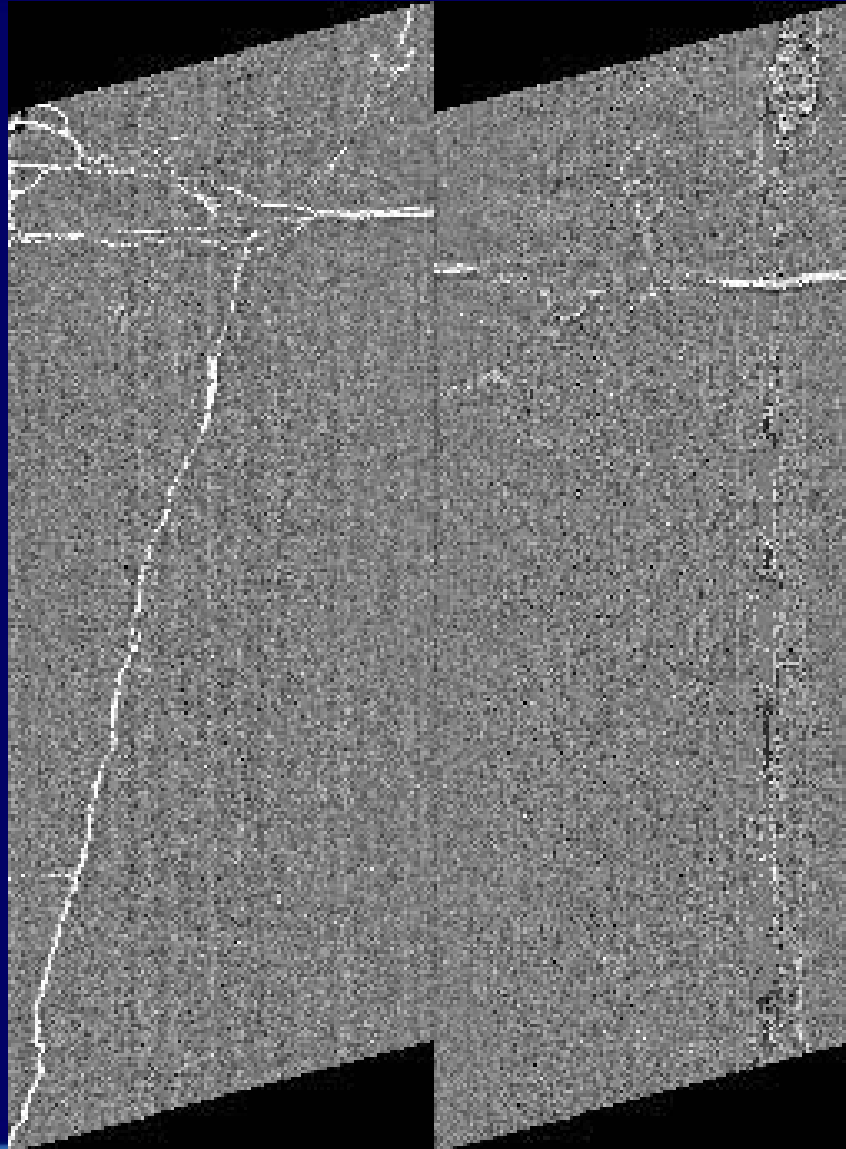

Crack detection (example)

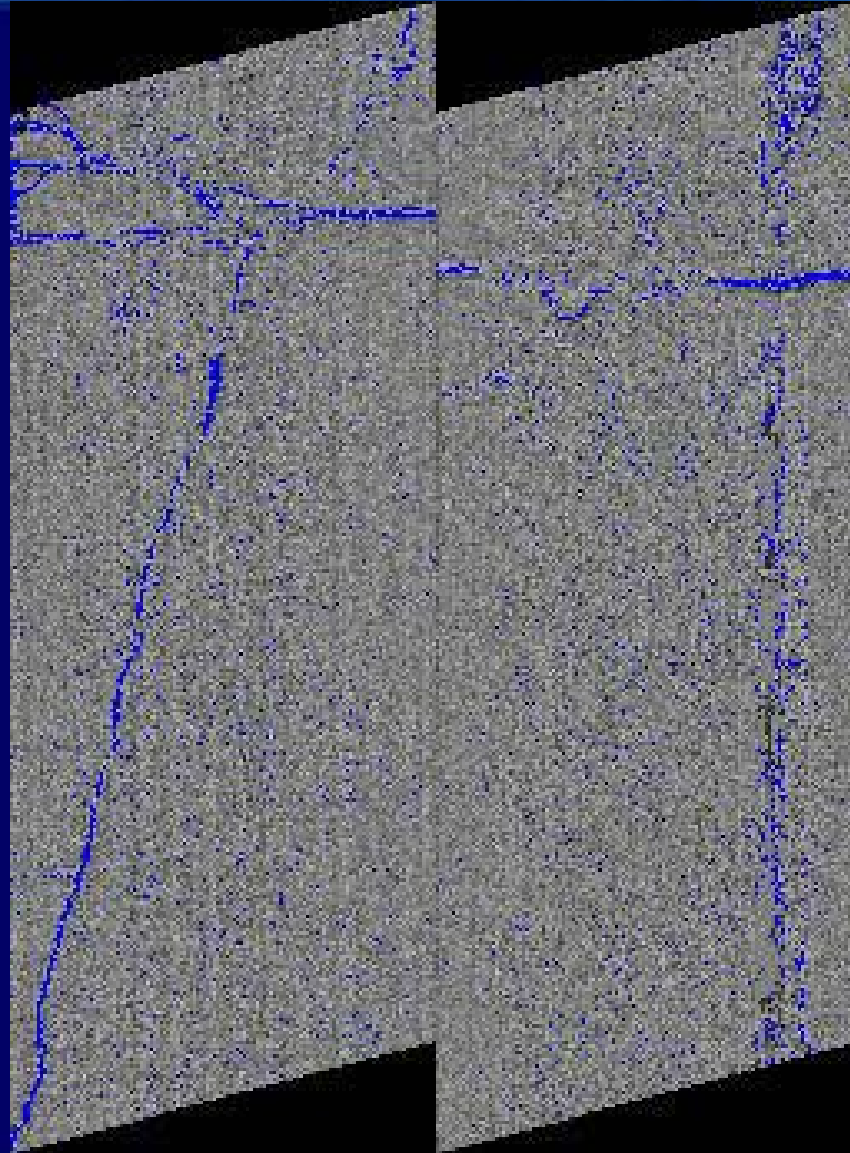

Crack detection (example)

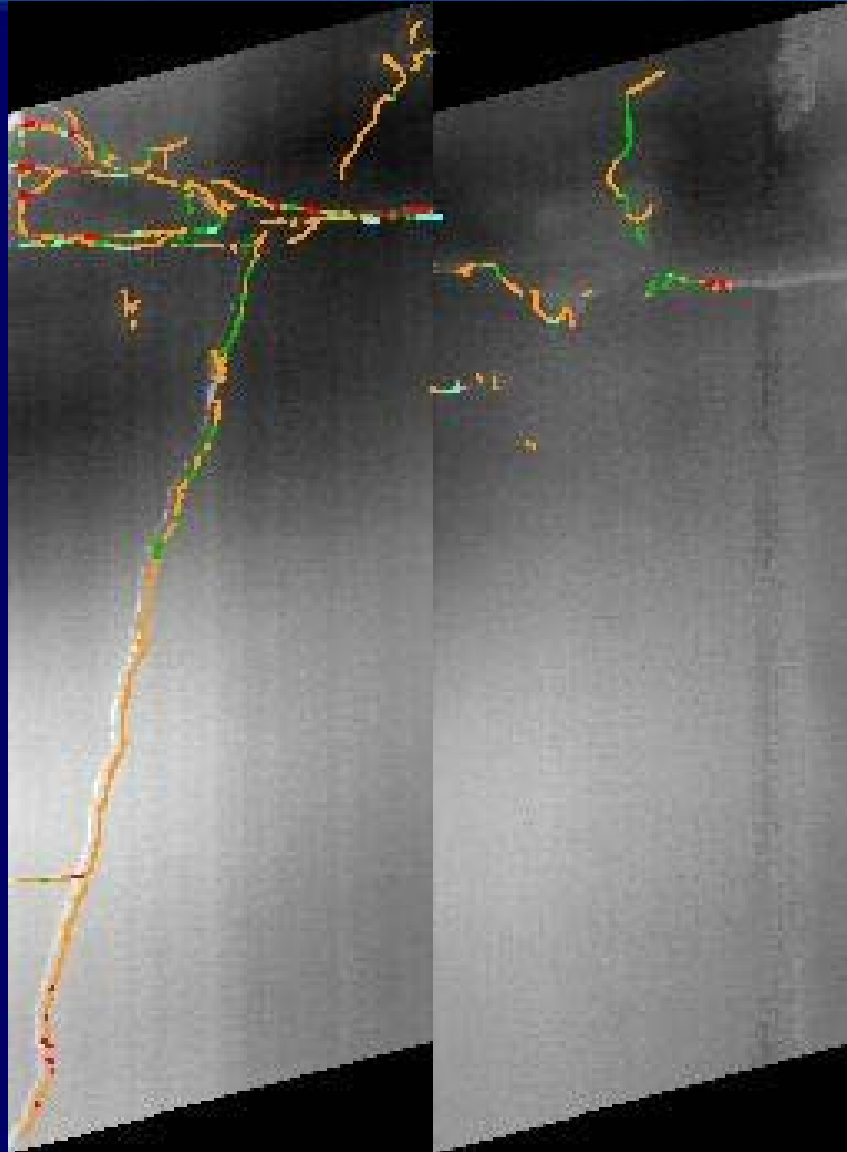

Crack detection (example)

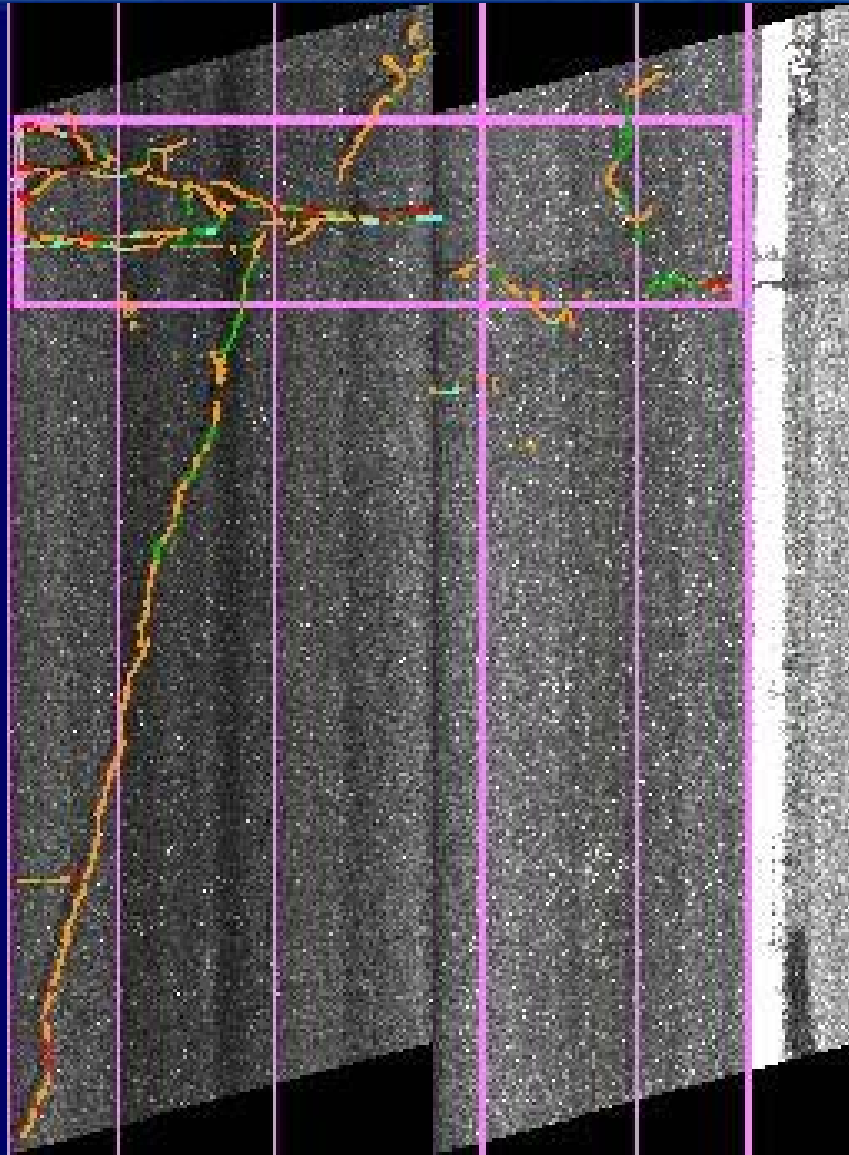

Network level testing



Network level validation tests

- 990 000 images of 10m sections were visually evaluated
- In all 9 900 km of road network was evaluated
- Visual results were seperated into 4 classes:

Good

OK

Bad

NA = other

Network level validation tests –criteria

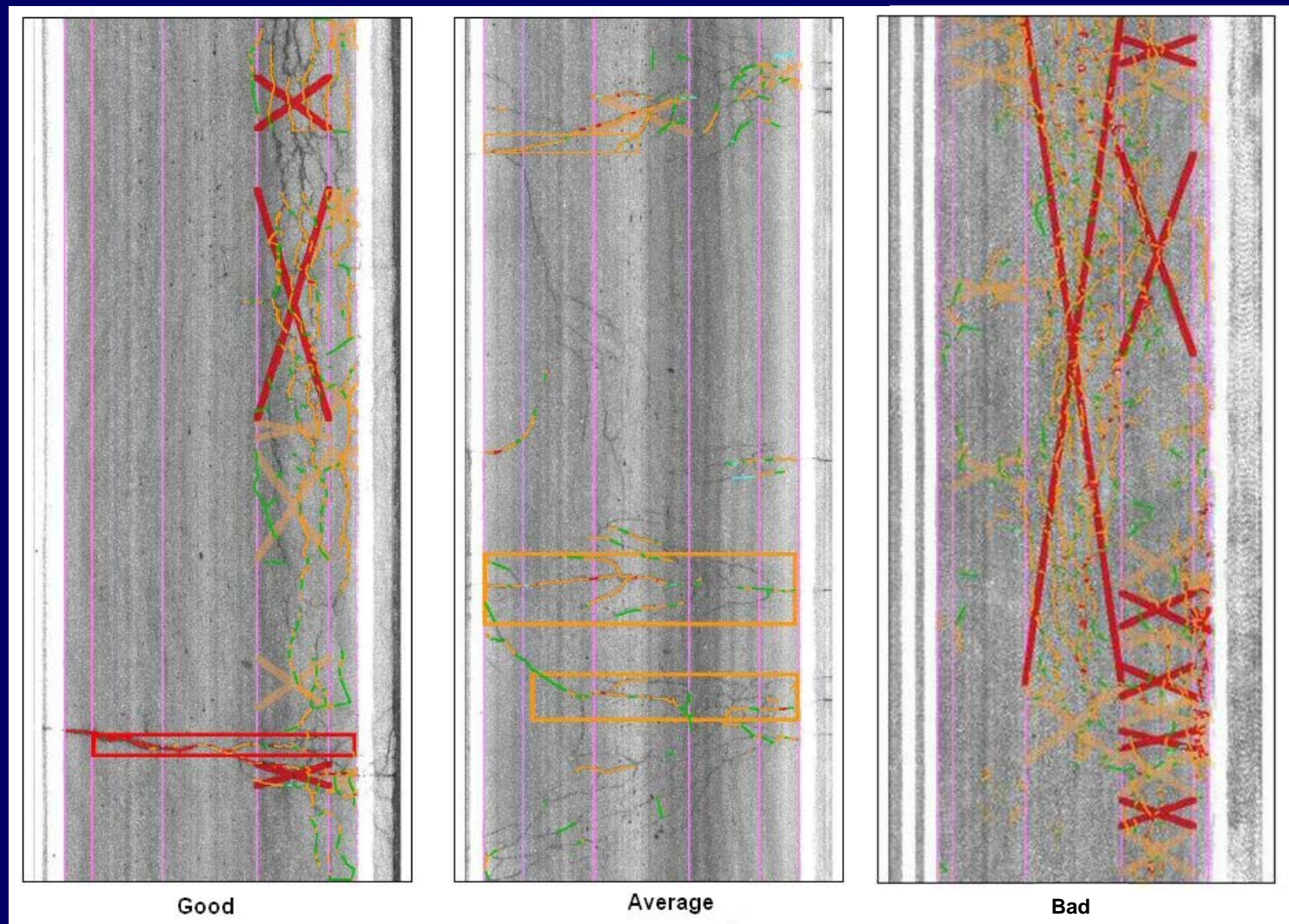

Results – network level visual evaluation

District #	Total (sections)	Results (manual classification)							
		Number of images (10m sections)				Proportion (%)			
		Good	Average	Bad	NA	Good	Average	Bad	NA
84	35288	34144	310	144	690	96,8	0,9	0,4	2,0
85	4243	4101	53	51	38	96,7	1,2	1,2	0,9
86	147903	144040	516	1520	1827	97,4	0,3	1,0	1,2
87	149926	138453	1170	5728	4575	92,3	0,8	3,8	3,1
88	189097	183010	1064	2002	3021	96,8	0,6	1,1	1,6
89	125003	121835	442	2015	711	97,5	0,4	1,6	0,6
90	123653	116930	2980	2434	1309	94,6	2,4	2,0	1,1
91 & 92	215513	213142	197	956	1218	98,9	0,1	0,4	0,6
Total	990626	955655	6732	14850	13389	96,5	0,7	1,5	1,4

Network level validation tests

- 77 000 images of 10m sections were compared to high resolution images of the same sections measured by a video camera.
- In all 770 km of road network was evaluated with this method.
- The criteria evaluated were the following:
 - Tranverse and longitudinal cracks
 - Patches
 - Pot holes
- Visual results were classified as follows per 10m:
 - Much less (missing 2 or more cracks)
 - Less (missing 1 crack)
 - Good
 - More (1+ false detection)

Results – network level visual evaluation

Defect type	Results (manual classification of 7700 images)							
	Number of images (10m sections)				Proportion (%)			
	Much Less	Less	Good	More	Much Less	Less	Good	More
Longitudinal cracks	632	1040	53429	854	1.1	1.9	95.5	1.6
Transverse cracks (complete + incomplete)	1426	5948	13962	744	1.3	5.5	89.8	3.4
Patches	430	1210	4926	95	6.5	18.2	74.0	1.5
Potholes	10	166	1982	55	0.5	7.5	89.6	2.5

LCMS Data example – Manhole

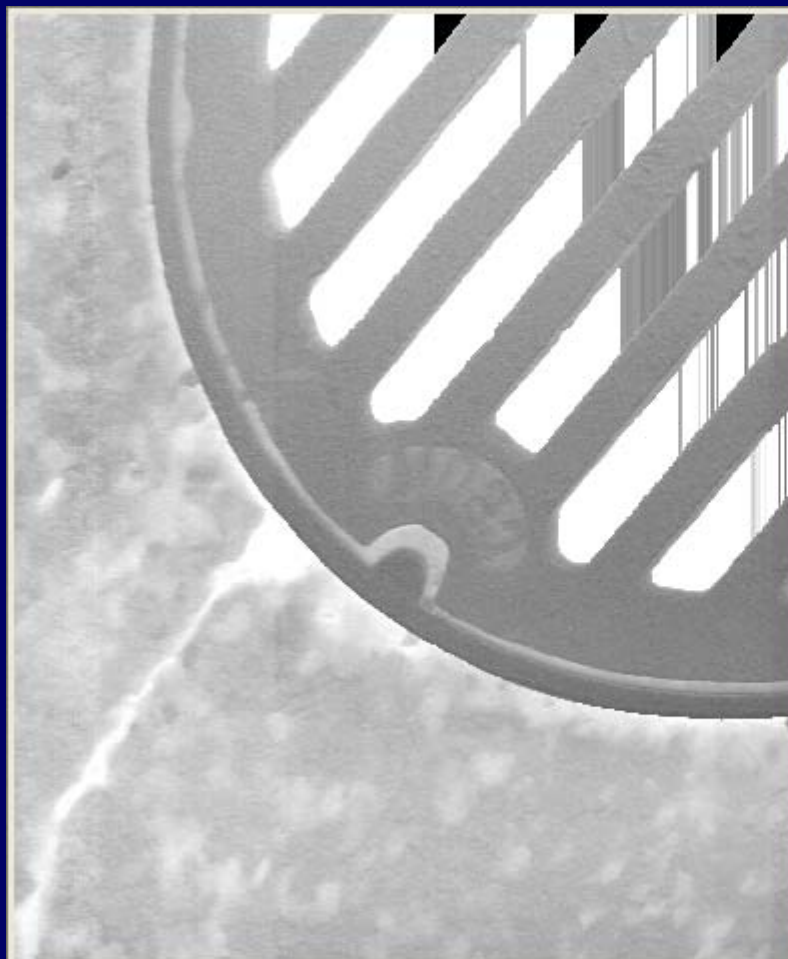

3D Range Data



2D Intensity Data

3D + 2D merged data with artificial lighting

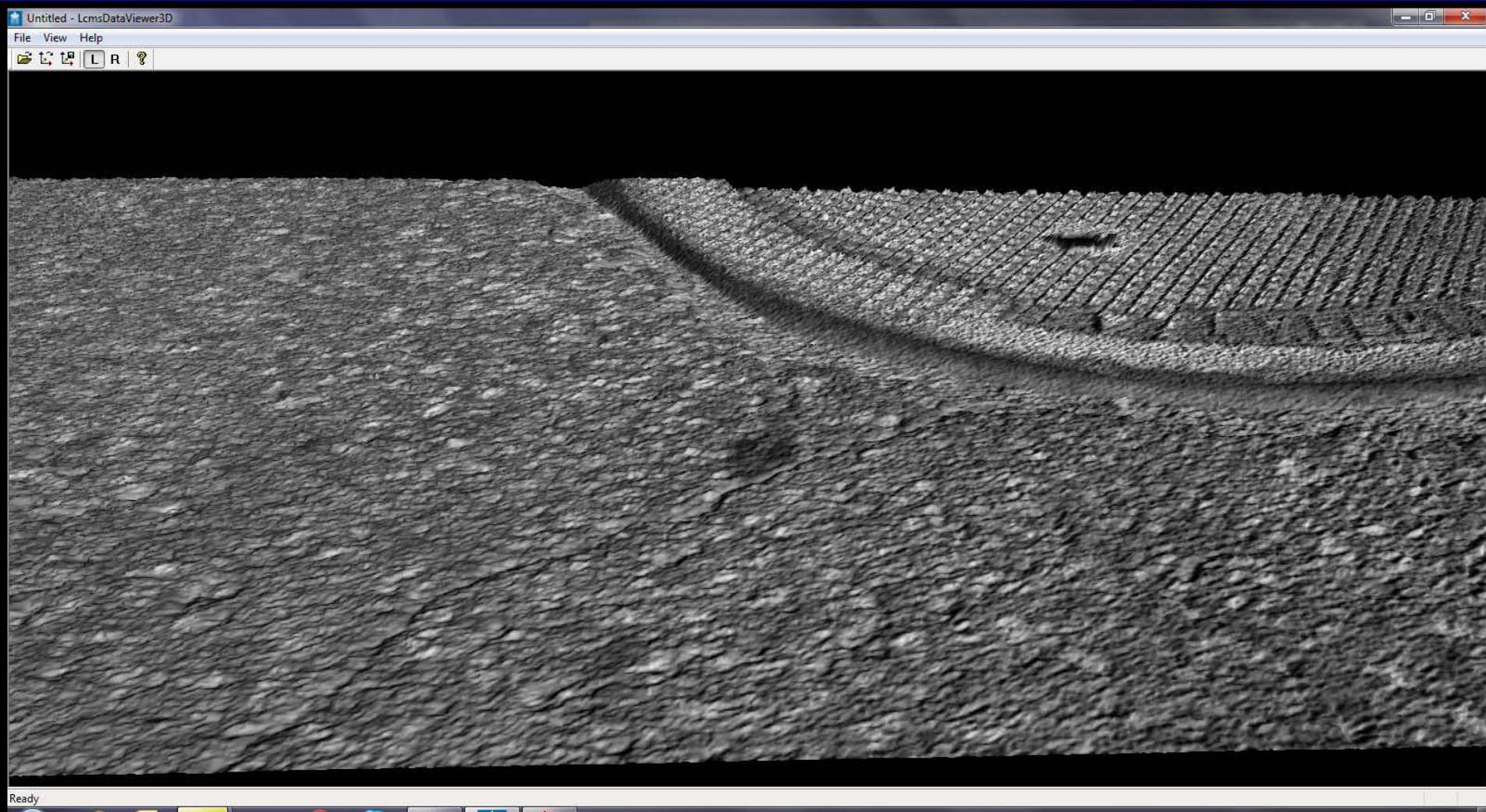

3D + 2D merged data with artificial lighting

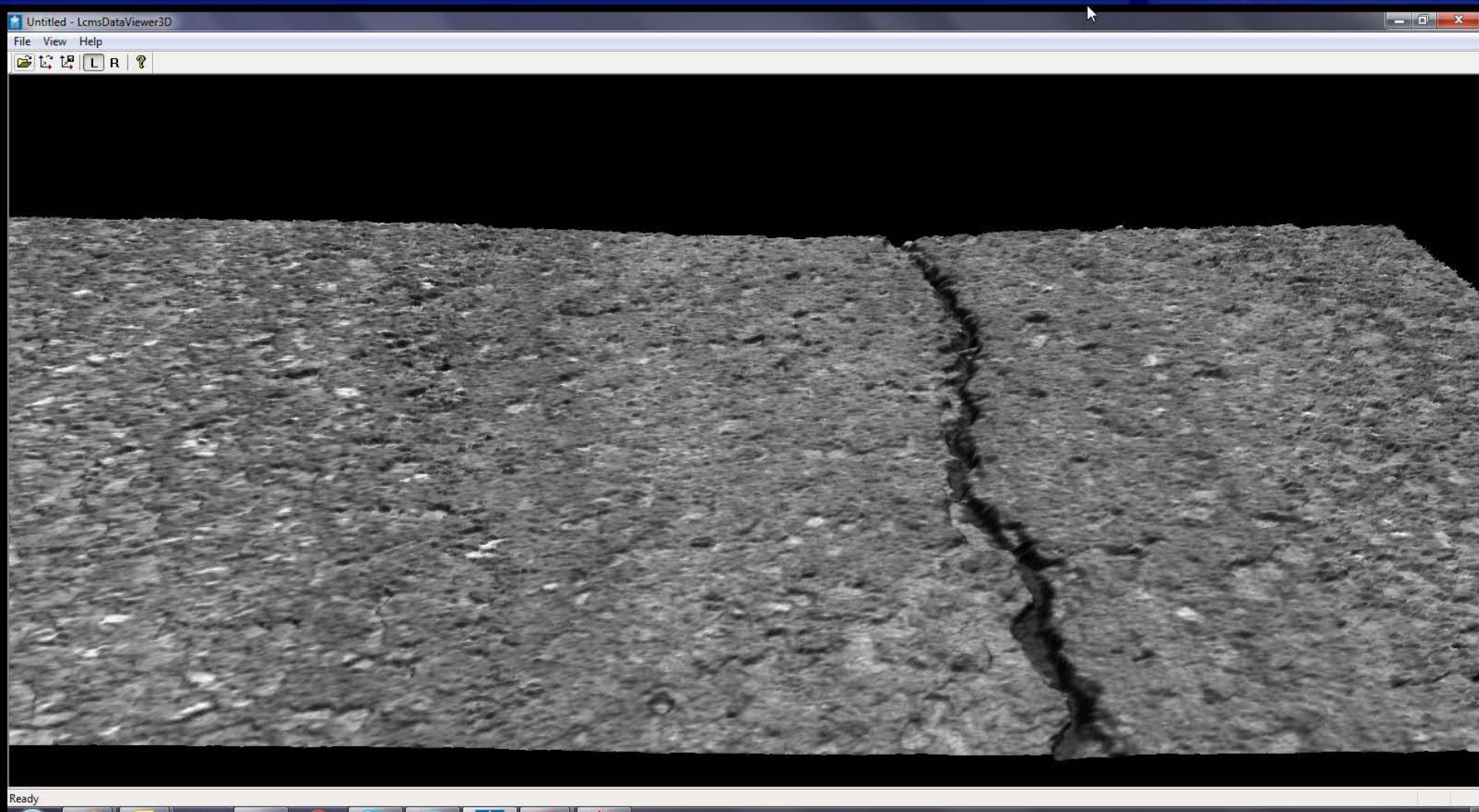

3D + 2D merged data – Maple Leaf + Texture



Conclusions

- A high performance new 3D transverse profiling system was developed and tested at the network level (10000km) and was evaluated for its ability to automatically detect and classify cracks.
- The system was found to be over 95% correct in the classification of cracks when the 3D crack data was visually present.
- The system was compared to 900 km of manual video analysis techniques and the system performance was measured to be:
 - 95% accurate for the detection of longitudinal cracks
 - 90% accurate for the detection of transverse cracks